

# CARACTERE

rochebobois  
PARIS

design Sacha LAKIC



# CARACTERE

rochebobois  
PARIS

design Sacha LAKIC



FU42

# CARACTERE

rochebobois  
PARIS

design Sacha LAKIC

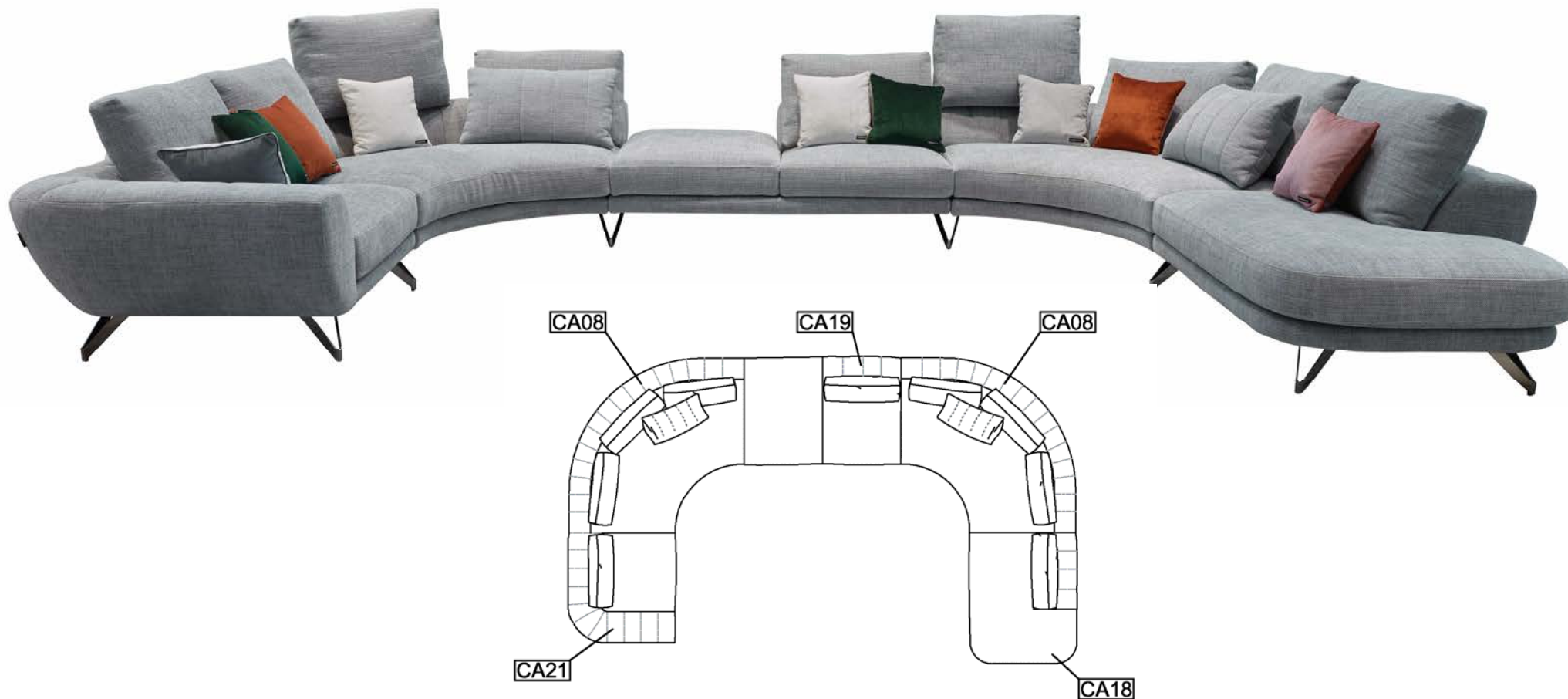

**CA21** Bâtard 1 place acc. G + **CA08** Grand angle rond + **CA19** Chauffeuse avec pouf G. + **CA08** Grand angle rond + **CA18** Petit Terminal arrondi D.  
Dossiers relevables avec mécanisme manuel.

**CA21** 1-seat 1-arm unit with left armrest + **CA08** Large round corner + **CA19** Armless chair and left ottoman + **CA08** Large round corner + **CA18** Small right round end unit  
Adjustable backs with manual mechanism

**CA21** Batard 1 plaza apy. G + **CA08** Gran ángulo redondo + **CA19** Chauffeuse y puf izquierdo + **CA08** Gran ángulo redondo + **CA18** Pequeño terminal redondo izquierdo  
Respaldos elevables con mecanismo manual.

FU42

# CARACTERE

rochebobois  
PARIS

design Sacha LAKIC



## INFORMATIONS TECHNIQUES / TECHNICAL SPECIFICATIONS / CARACTERISTICAS TECNICAS:

Structure : Sapin massif, multiplis de sapin et panneaux de particules

Suspension : Sangles élastiques entrecroisées

Coussins d'assise : Mousse bi-densité 30-40 kg/m<sup>3</sup>, fibre polyester 200 g/m<sup>2</sup> et vellutino

Coussins de dossier :

Version dossiers relevables : Mousse bi-densité 21-25 kg/m<sup>3</sup> et couette de plumes d'oie et canard

Version dossiers fixes avec rouleau : Mousse et fibres

Piètement : Métal teinté finition Chrome Noir

Structure: Solid firwood, fir plywood and engineered composite wood

Suspension: Cross-webbing elastic straps

Seat cushion: Bi-density foam 30-40 kg/m<sup>3</sup>, polyester fibre 200 g/m<sup>2</sup> and Vellutino

Back cushions:

Adjustable backs version: Bi-density foam 21-25 kg/m<sup>3</sup> and goose and duck feathers duvet

Fixed backs with bolster version: Foam and fibres

Base: Stained metal with black chrome-plated finish

Estructura: Abeto macizo, multilaminado de abeto y paneles de partículas.

Suspensión: Cinchas elásticas entrecruzadas

Cojines de asiento: Espuma bi-densidad 30-40 kg/m<sup>3</sup>, fibra poliéster 200 g/m<sup>2</sup> y vellutino

Cojines de respaldo:

Versión respaldos elevables: Espuma bi-densidad 21-25 kg/m<sup>3</sup> y acolchado de plumas de oca y pato

Versión respaldos fijos con rulo: Espuma y fibras

Patatas: Metal tintado acabado cromado negro

## OBSERVATIONS / OBSERVATIONS / OBSERVACIONES:

- Fabrication Européenne

- Modèle réalisable dans tous les revêtements de la collection ROCHE BOBOIS

- Manufactured in Europe

- Model available in all materials from the ROCHE BOBOIS collection

- Fabricación europea

- Modelo disponible en todas los revestimientos de la colección ROCHE BOBOIS

# CARACTERE

design Sacha LAKIC

## DOSSIERS FIXES / FIXED BACK / RESPALDOS FIJOS 1/2

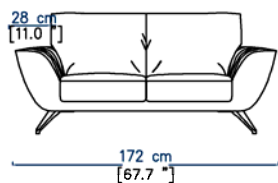
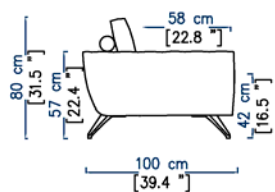

**CA02**  
CANAPE 2 PLACES DOSSIERS FIXES  
2-SEATS SOFA FIXED BACKS  
SOFÁ 2 PLAZAS RESPALDOS FIJOS

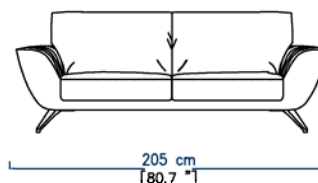

**CA03**  
CANAPE 3 PLACES DOSSIERS FIXES  
3-SEATS SOFA FIXED BACKS  
SOFÁ 3 PLAZAS RESPALDOS FIJOS

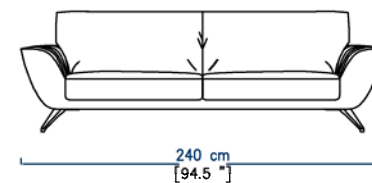

**CA04**  
GRAND CANAPE 3 PLACES DOSSIERS FIXES  
LARGE 3-SEATS SOFA FIXED BACKS  
GRAN SOFÁ 3 PLAZAS RESPALDOS FIJOS

# CARACTERE

design Sacha LAKIC

## DOSSIERS FIXES / FIXED BACK / RESPALDOS FIJOS 2/2

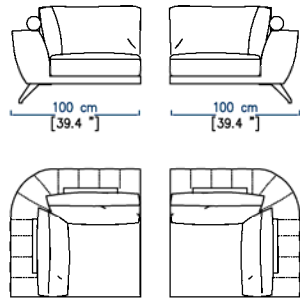
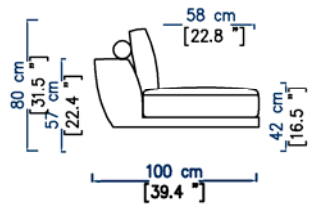

**CA12**  
ANGLE CARRE DOSSIERS FIXES  
SQUARE CORNER FIXED BACKS  
ÁNGULO QUADRADO RESPALDOS FIJOS

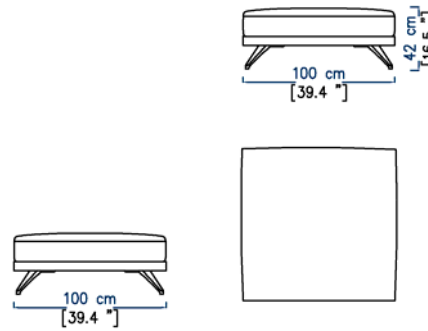

**CA29**  
POUF CARRE  
SQUARE OTTOMAN  
PUF QUADRADO

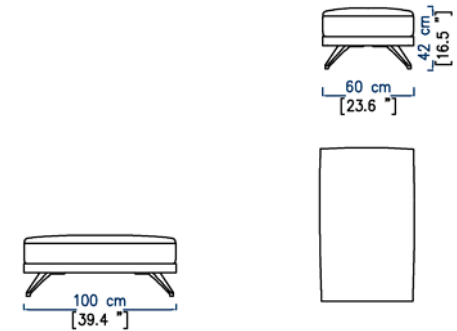

**CA30**  
POUF RECTANGULAIRE  
RECTANGULAR OTTOMAN  
PUF RECTANGULAR

# CARACTERE

rochebobois  
PARIS

design Sacha LAKIC

## DOSSIERS RELEVABLES / ADJUSTABLE BACK / RESPALDOS ELEVABLES 1/5

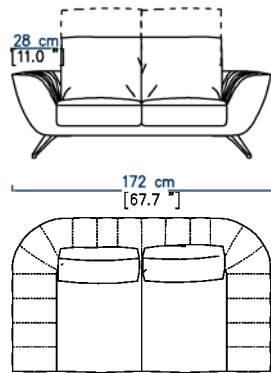
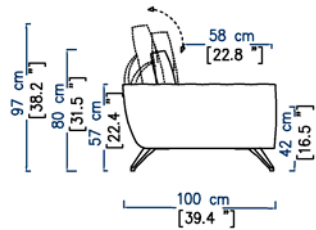

**CA05**  
CANAPE 2 PLACES DOSSIERS RELEVABLES  
2-SEATS SOFA ADJUSTABLE BACKS  
SOFÁ 2 PLAZAS RESPALDOS ELEVABLES

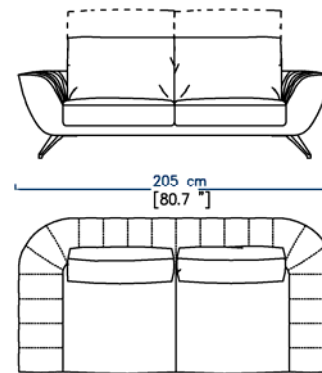

**CA06**  
CANAPE 3 PLACES DOSSIERS RELEVABLES  
3-SEATS SOFA ADJUSTABLE BACKS  
SOFÁ 3 PLAZAS RESPALDOS ELEVABLES

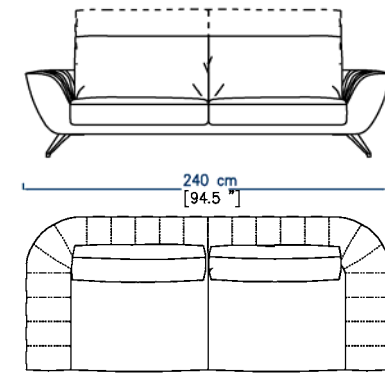

**CA07**  
GRAND CANAPE 3 PLACES DOSSIERS RELEVABLES  
LARGE 3-SEATS SOFA ADJUSTABLE BACKS  
GRAN SOFÁ 3 PLAZAS RESPALDOS ELEVABLES

# CARACTERE

design Sacha LAKIC

## DOSSIERS RELEVABLES / ADJUSTABLE BACK / RESPALDOS ELEVABLES 2/5

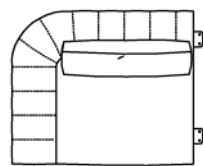
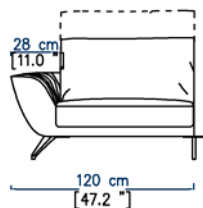
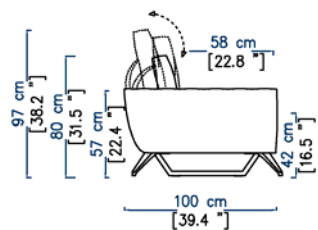

**CA23**

BATARD 1 PLACE ACC. GAUCHE DOSSIER RELEVABLE  
1-SEAT 1-ARM UNIT LEFT ARMREST ADJUSTABLE BACK  
BATARD 1 PL. APY IZQUIERDO RESPALDO ELEVABLE

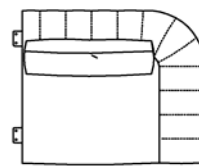
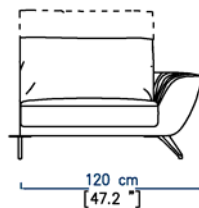

**CA24**

BATARD 1 PLACE ACC. DROIT DOSSIER RELEVABLE  
1-SEAT 1-ARM UNIT RIGHT ARMREST ADJUSTABLE BACK  
BATARD 1 PL. APY DERECHO RESPALDO ELEVABLE

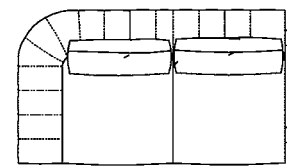
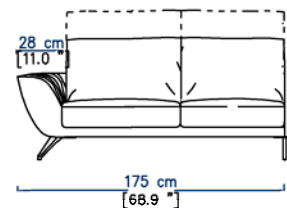

**CA25**

BATARD 2 PLACES ACC. GAUCHE DOSSIER RELEVABLES  
2-SEAT 1-ARM UNIT LEFT ARMREST ADJUSTABLE BACKS  
BATARD 2 PL. APY IZQUIERDO RESPALDOS ELEVABLES

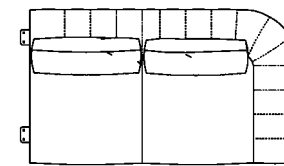
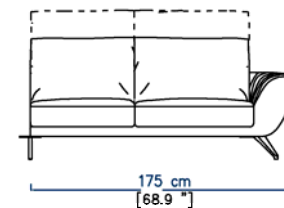

**CA26**

BATARD 2 PLACES ACC. DROIT DOSSIER RELEVABLES  
2-SEAT 1-ARM UNIT RIGHT ARMREST ADJUSTABLE BACKS  
BATARD 2 PL. APY DERECHO RESPALDOS ELEVABLES

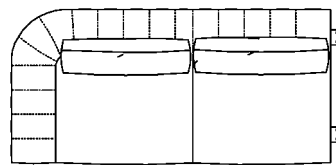
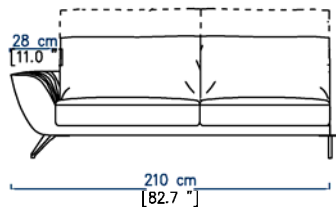
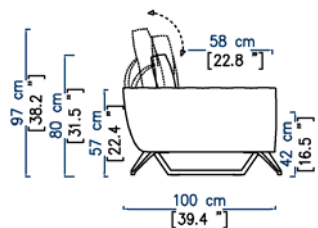

**CA27**

BATARD 3 PLACES ACC. GAUCHE DOSSIER RELEVABLES  
3-SEAT 1-ARM UNIT LEFT ARMREST ADJUSTABLE BACKS  
BATARD 3 PL. APY IZQUIERDO RESPALDOS ELEVABLES

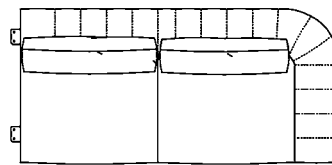
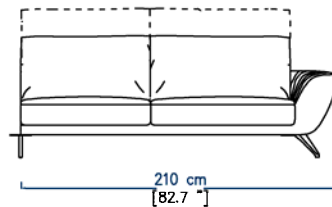

**CA28**

BATARD 3 PLACES ACC. DROIT DOSSIER RELEVABLES  
3-SEAT 1-ARM UNIT RIGHT ARMREST ADJUSTABLE BACKS  
BATARD 3 PL. APY DERECHO RESPALDOS ELEVABLES



# CARACTERE

design Sacha LAKIC

## DOSSIERS RELEVABLES / ADJUSTABLE BACK / RESPALDOS ELEVABLES 3/5

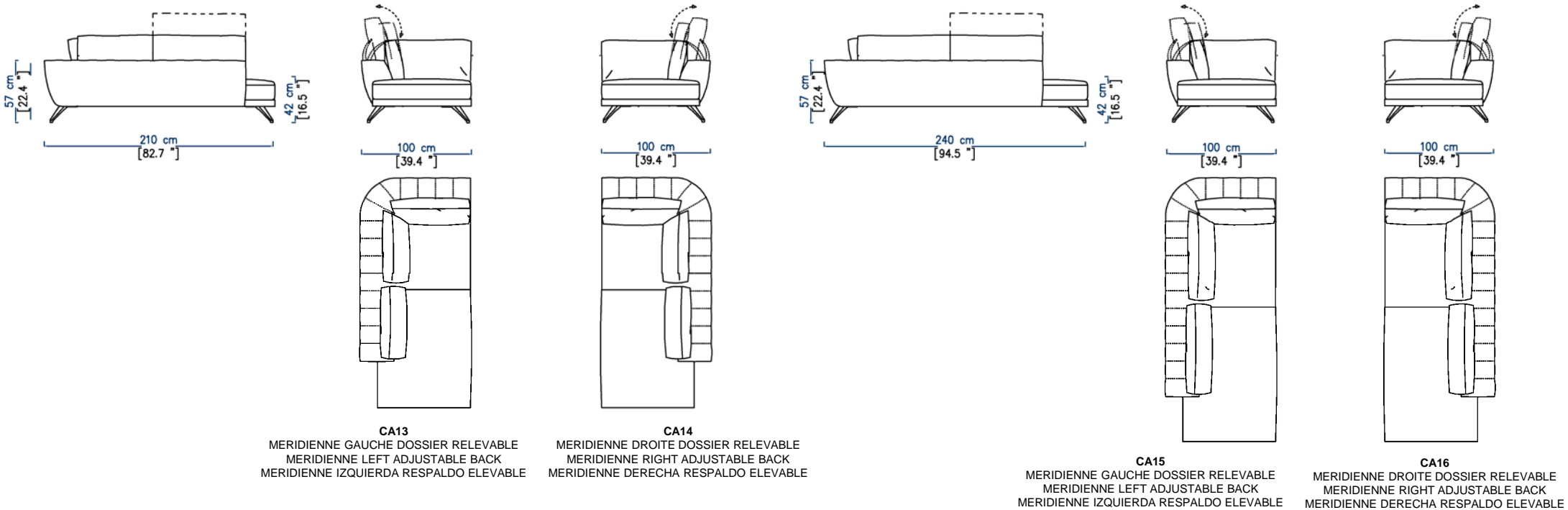

# CARACTERE

rochebobo  
PARIS

design Sacha LAKIC

## DOSSIERS RELEVABLES / ADJUSTABLE BACK / RESPALDOS ELEVABLES 4/5

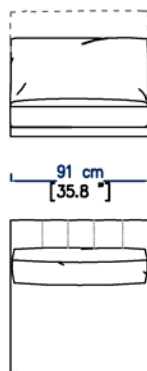
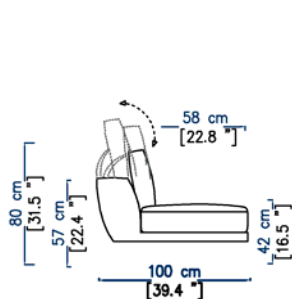

CA09

CHAUFFEUSE DOSSIER RELEVABLE  
ARMLESS CHAIR ADJUSTABLE BACK  
CHAUFFEUSE RESPALDO ELEVABLE

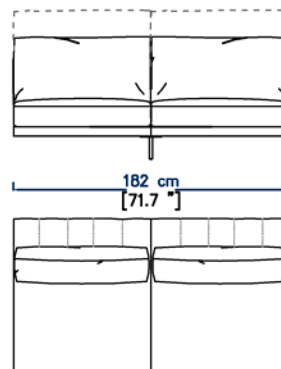
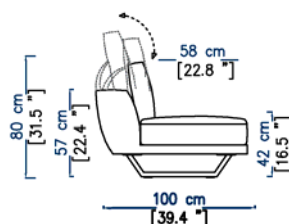

CA10

BANQUETTE 2,5 PLACES DOSSIER RELEVABLES  
2.5-SEAT ARMLESS SOFA ADJUSTABLE BACKS  
BANQUETA 2,5 PLAZAS RESPALDOS ELEVABLES

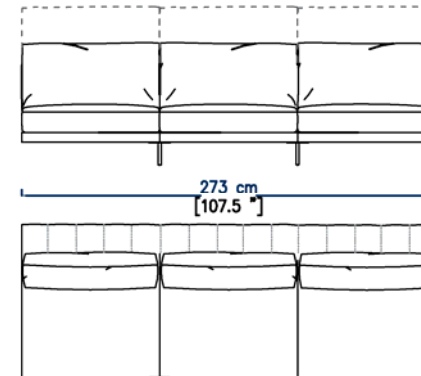

CA11

GRANDE BANQUETTE 4 PLACES DOSSIER RELEVABLES  
LARGE 4-SEAT ARMLESS SOFA ADJUSTABLE BACKS  
GRAN BANQUETA 4 PLAZAS RESPALDOS ELEVABLES

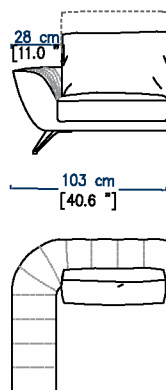
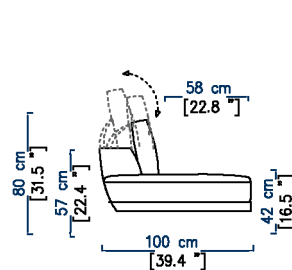

CA21

BATARD 1 PLACE ACC. GAUCHE DOSSIER RELEVABLE  
1-SEAT 1-ARM UNIT LEFT ARMREST ADJUSTABLE BACK  
BATARD 1 PL. APY IZQUIERDO RESPALDO ELEVABLE

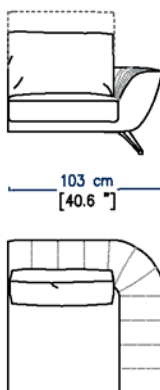

CA22

BATARD 1 PLACE ACC. DROIT DOSSIER RELEVABLE  
1-SEAT 1-ARM UNIT RIGHT ARMREST ADJUSTABLE BACK  
BATARD 1 PL. APY DERECHO RESPALDOS ELEVABLE

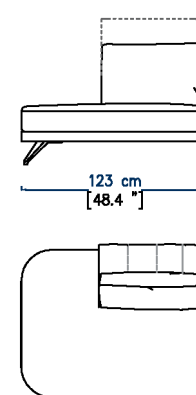

CA17

PETIT TERMINAL ARRONDI GAUCHE DOSSIER RELEVABLE  
SMALL ROUND END UNIT LEFT ADJUSTABLE BACK  
PEQUEÑO TERMINAL REDONDO IZQUIERDO RESPALDO ELEVABLE

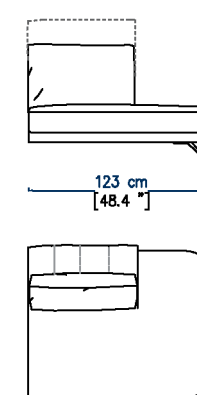

CA18

PETIT TERMINAL ARRONDI DROIT DOSSIER RELEVABLE  
SMALL ROUND END UNIT RIGHT ADJUSTABLE BACK  
PEQUEÑO TERMINAL REDONDO DERECHO RESPALDO ELEVABLE

# CARACTERE

design Sacha LAKIC

## DOSSIERS RELEVABLES / ADJUSTABLE BACK / RESPALDOS ELEVABLES 5/5

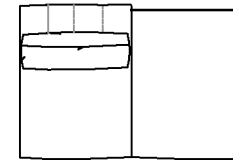
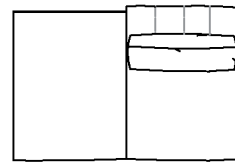
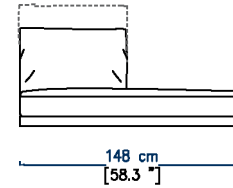
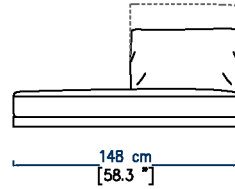
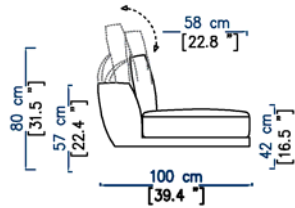

CA19

CHAUFFEUSE AVEC POUF GAUCHE DOSSIER RELEVABLE  
ARMLESS CHAIR WITH LEFT OTTOMAN ADJUSTABLE BACK  
CHAUFFEUSE Y PUF IZQUIERDO RESPALDO ELEVABLE

CA20

CHAUFFEUSE AVEC POUF DROIT DOSSIER RELEVABLE  
ARMLESS CHAIR WITH RIGHT OTTOMAN ADJUSTABLE BACK  
CHAUFFEUSE Y PUF DERECHO RESPALDO ELEVABLE

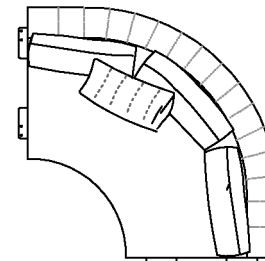
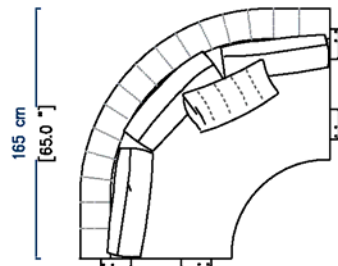
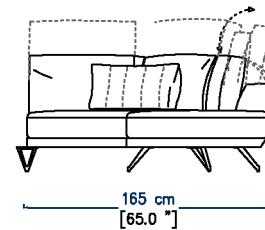
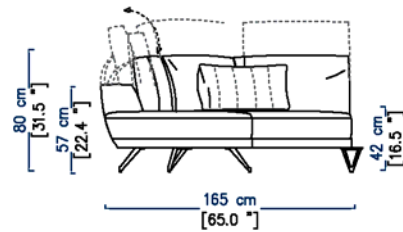

CA08

GRAND ANGLE ROND DOSSIERS RELEVABLES  
LARGE ROUND CORNER ADJUSTABLE BACKS  
GRAN ANGULO REDONDO RESPALDOS ELEVABLES